

www.heated-towel-rails-warmers.co.uk is a trading name of (Clayton Horsnell LTD)

We are an established company which is rapidly growing. The company runs along side a family business with over 40 years of experience in trade, retail and distribution in the plumbing and heating industry. Our product range and suppliers are from the best in the business and by using these suppliers we assure and maintain quality products to our customers

Milano 1775H X 600W White Flat Towel Warmer



Milano 1775H X 600W White Flat Towel Warmer

Price

Your Price: £184.99

Comprehensive, 5 year guarantee.

Product Features

- 1775mm High X 600mm Wide
- Output Delta T 50K = 833 watts (3860 BTU's)

Product Characteristics

- Wall mounted 'ladder' style.
- Ideal for Bathrooms, En-suites, Kitchens and Cloakrooms.
- Tough, white epoxy polyester finish (Ral 9101 white).
- Made from high quality tubular steel.
- Fully tested to EN442.
- Installation kit includes wall brackets, air vent and end plug.
- Maximum operating pressure 8 bar.

These towel rails are designed for high efficiency (Condensing) heating systems, which gives you the same heat output as a 60k conventional system rail. This produces a much higher heat output for both non condensing systems. Please do not think you can only fit this on only high efficiency systems. Condensing boilers run at a 10k lower temperature than a conventional boiler system. The result of this is a compensation for any loss of heat from the heated towel rail.

Technical Diagram

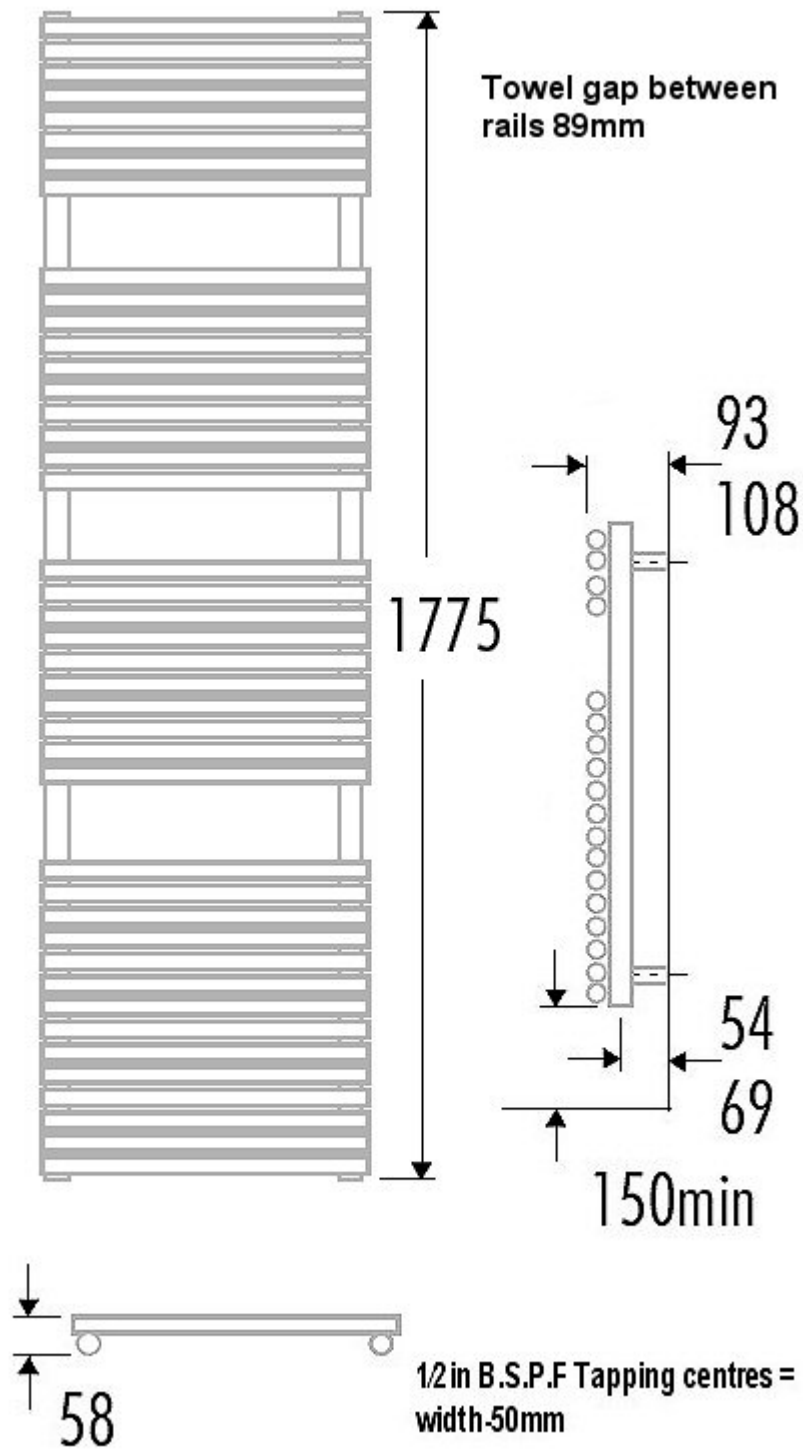

When you order a rail and element together the correct sized element is supplied.

Please add an element to your shopping basket to make the rail dual fuel, which makes the rail work in the summer as well, so you can dry your towels all year around. From our point of view, this is a must have when buying the rail for bathroom use.

Contact Us

Head Office (Not show Room)
Clayton Horsnell LTD
Unit 6
Corporation Yard
2a Harwich Road
Colchester
Essex
CO4 3BN

Essex Show Room







This show room is used in conjunction with
CC Discount Heating LTD & Clayton Horsnell Ltd
as it is part of a family business :-
2 – 4 Harwich Road
Colchester
Essex
CO4 3BN

www.heated-towel-rails-warmers.co.uk

Email addresses

Trade & Retail inquires sales@tradeplumbing.co.uk
Returns sales@tradeplumbing.co.uk
Web promotions/suggestions/problems sales@tradeplumbing.co.uk
Advertising sales@tradeplumbing.co.uk

PROBLEMS ORDERING ON LINE:-

Any ordering problems please contact support at sales@tradeplumbing.co.uk

Normally most problems when ordering are Ad-aware popup blockers. To solve this go to tools and internet options clear the cookies & history as this solves 90% of order problems.

Some times you will have to disable your popup blocker or allow pop-ups from our site. If you do have any problems or find faults on our website please email sales@tradeplumbing.co.uk .

WHY NO TELEPHONE NUMBERS FOR ORDERING

If you would like to contact us directly we do offer an e-mail/phone back service but this is for limited usage as we prioritise emails. All you have to do is email us your information and any questions you need answering. We will either reply by phone/email with the answer to any questions.

We do this to cut costs of using a call centre thus competitive prices in reflection.

NEED HELP

We have added a mobile phone number to help you if in you need to consult someone in a difficult situation. We only offer these services as the last resort for you as the customer.

We do not have a phone system as this will increase the prices of our products. As a company that prides itself on customer service and competitive pricing we give you - the customer the best price in the UK and to do this we have to cut costs.

**IF YOU DO NEED TO CONTACT US BY PHONE PLEASE CALL
(BETWEEN THE HOURS OF 9AM-5PM ONLY ON 0870 803 4288.
ONE OF THE TEAM WILL TRY TO HELP WITH YOUR PROBLEM**